



# R&TTE (99/5/EC ) Directive

## EN 300 440-2 V 1.4.1: 2010

### TEST REPORT

FOR

**Product Name:** TomTom Golfer GPS watch

**Brand Name:** TomTom

**Model No.:** 8RG0

**Model Different:** N/A

**Report No.:** E2/2014/80003

**Issue Date:** Aug. 21, 2014

**Prepared for:** TomTom International B.V.  
De Ruijterkade 154, 1011 AC Amsterdam The Netherlands

**Prepared by:** SGS Taiwan Ltd.  
Electronics & Communication Laboratory  
No.2, Keji 1st Rd., Guishan Township, Taoyuan County, Taiwan 333



*Note: This report shall not be reproduced except in full, without the written approval of SGS Taiwan Ltd. This document may be altered or revised by SGS Taiwan Ltd. personnel only, and shall be noted in the revision section of the document.*

Unless otherwise stated the results shown in this test report refer only to the sample(s) tested and such sample(s) are retained for 90 days only.  
除非另有說明，此報告結果僅對測試之樣品負責，同時此樣品僅保留90天。本報告未經本公司書面許可，不可部份複製。

This document is issued by the Company subject to its General Conditions of Service printed overleaf, available on request or accessible at [www.sgs.com/terms\\_and\\_conditions.htm](http://www.sgs.com/terms_and_conditions.htm) and, for electronic format documents, subject to Terms and Conditions for Electronic Documents at [www.sgs.com/terms\\_e-document.htm](http://www.sgs.com/terms_e-document.htm). Attention is drawn to the limitation of liability, indemnification and jurisdiction issues defined therein. Any holder of this document is advised that information contained hereon reflects the Company's findings at the time of its intervention only and within the limits of Client's instructions, if any. The Company's sole responsibility is to its Client and this document does not exonerate parties to a transaction from exercising all their rights and obligations under the transaction documents. This document cannot be reproduced except in full, without prior written approval of the Company. Any unauthorized alteration, forgery or falsification of the content or appearance of this document is unlawful and offenders may be prosecuted to the fullest extent of the law.

## VERIFICATION OF COMPLIANCE

**Applicant:** TomTom International B.V.  
De Ruijterkade 154, 1011 AC Amsterdam The Netherlands

**Product Name:** TomTom Golfer GPS watch

**Brand Name:** TomTom

**Model No.:** 8RG0

**Model Different:** N/A

**File Number:** E2/2014/80003

**Date of Test:** Aug. 01, 2014 ~ Aug. 15, 2014

**Date of EUT Received:** Aug. 01, 2014

APPLICABLE STANDARDS	
STANDARD	TEST RESULT
ETSI EN 300 440-1 v1.6.1:2010 ETSI EN 300 440-2 v1.4.1:2010	Complied

The above equipment was tested by SGS Taiwan Ltd. Electronics & Communication Laboratory for compliance with the requirements set forth in the European Standard ETSI EN 300 440-2 v1.4.1: 2010. under R&TTE Directive 99/05/EC. The results of testing in this report apply to the product/system that was tested only. Other similar equipment will not necessarily produce the same results due to production tolerance and measurement uncertainties.

**Test By:** Jazz Huang **Date:** Aug. 21, 2014

*Jazz Huang / Sr. Engineer*

**Prepared By:** Violetta Tang **Date:** Aug. 21, 2014

*Violetta Tang / Clerk*

**Approved By:** Jim Chang **Date:** Aug. 21, 2014

*Jim Chang / Supervisor*

Unless otherwise stated the results shown in this test report refer only to the sample(s) tested and such sample(s) are retained for 90 days only.  
除非另有說明，此報告結果僅對測試之樣品負責，同時此樣品僅保留90天。本報告未經本公司書面許可，不可部份複製。

This document is issued by the Company subject to its General Conditions of Service printed overleaf, available on request or accessible at [www.sgs.com/terms\\_and\\_conditions.htm](http://www.sgs.com/terms_and_conditions.htm) and, for electronic format documents, subject to Terms and Conditions for Electronic Documents at [www.sgs.com/terms\\_e-document.htm](http://www.sgs.com/terms_e-document.htm). Attention is drawn to the limitation of liability, indemnification and jurisdiction issues defined therein. Any holder of this document is advised that information contained hereon reflects the Company's findings at the time of its intervention only and within the limits of Client's instructions, if any. The Company's sole responsibility is to its Client and this document does not exonerate parties to a transaction from exercising all their rights and obligations under the transaction documents. This document cannot be reproduced except in full, without prior written approval of the Company. Any unauthorized alteration, forgery or falsification of the content or appearance of this document is unlawful and offenders may be prosecuted to the fullest extent of the law.

## Version

Version No.	Date	Description
00	Aug. 21, 2014	Initial creation of document

Unless otherwise stated the results shown in this test report refer only to the sample(s) tested and such sample(s) are retained for 90 days only.

除非另有說明，此報告結果僅對測試之樣品負責，同時此樣品僅保留90天。本報告未經本公司書面許可，不可部份複製。

This document is issued by the Company subject to its General Conditions of Service printed overleaf, available on request or accessible at [www.sgs.com/terms\\_and\\_conditions.htm](http://www.sgs.com/terms_and_conditions.htm) and, for electronic format documents, subject to Terms and Conditions for Electronic Documents at [www.sgs.com/terms\\_e-document.htm](http://www.sgs.com/terms_e-document.htm). Attention is drawn to the limitation of liability, indemnification and jurisdiction issues defined therein. Any holder of this document is advised that information contained hereon reflects the Company's findings at the time of its intervention only and within the limits of Client's instructions, if any. The Company's sole responsibility is to its Client and this document does not exonerate parties to a transaction from exercising all their rights and obligations under the transaction documents. This document cannot be reproduced except in full, without prior written approval of the Company. Any unauthorized alteration, forgery or falsification of the content or appearance of this document is unlawful and offenders may be prosecuted to the fullest extent of the law.

## TABLE OF CONTENTS

<b>1. DESCRIPTION OF EQUIPMENT UNDER TEST (EUT)</b> .....	<b>5</b>
<b>2. DESCRIPTION OF TEST MODES</b> .....	<b>6</b>
<b>3. TEST FACILITY</b> .....	<b>6</b>
<b>4. BLOCK DIAGRAM OF TEST SETUP</b> .....	<b>7</b>
<b>5. MEASUREMENT UNCERTAINTY</b> .....	<b>8</b>
<b>6. TRANSMITTER REQUIREMENTS</b> .....	<b>9</b>
6.1. ETSI EN 300 440-2 SUBCLAUSE 4.2.1.1: EQUIVALENT ISOTROPICALLY RADIATED POWER .....	9
6.2. ETSI EN 300 440-2 SUBCLAUSE 4.2.1.2: PERMITTED RANGE OF OPERATING FREQUENCIES.....	13
6.3. ETSI EN 300 440-2 SUBCLAUSE 4.2.1.3: SPURIOUS EMISSIONS OF TRANSMITTER .....	15
6.4. ETSI EN 300 440-2 SUBCLAUSE 4.2.2.1: THE ADJACENT CHANNEL SELECTIVITY-IN-BAND .....	16
6.5. ETSI EN 300 440-2 SUBCLAUSE 4.2.2.2: BLOCKING OR DESENSITIZATION.....	16
6.6. ETSI EN 300 440-2 SUBCLAUSE 4.2.2.3: SPURIOUS EMISSIONS.....	16
6.7. ETSI EN 300 440-2 SUBCLAUSE 6: INTERPRETATION OF MEASUREMENT RESULTS.....	20
<b>PHOTOGRAPHS OF TEST SETUP</b> .....	<b>21</b>
<b>PHOTOGRAPHS OF EUT</b> .....	<b>24</b>

Unless otherwise stated the results shown in this test report refer only to the sample(s) tested and such sample(s) are retained for 90 days only.

除非另有說明，此報告結果僅對測試之樣品負責，同時此樣品僅保留90天。本報告未經本公司書面許可，不可部份複製。

This document is issued by the Company subject to its General Conditions of Service printed overleaf, available on request or accessible at [www.sgs.com/terms\\_and\\_conditions.htm](http://www.sgs.com/terms_and_conditions.htm) and, for electronic format documents, subject to Terms and Conditions for Electronic Documents at [www.sgs.com/terms\\_e-document.htm](http://www.sgs.com/terms_e-document.htm). Attention is drawn to the limitation of liability, indemnification and jurisdiction issues defined therein. Any holder of this document is advised that information contained hereon reflects the Company's findings at the time of its intervention only and within the limits of Client's instructions, if any. The Company's sole responsibility is to its Client and this document does not exonerate parties to a transaction from exercising all their rights and obligations under the transaction documents. This document cannot be reproduced except in full, without prior written approval of the Company. Any unauthorized alteration, forgery or falsification of the content or appearance of this document is unlawful and offenders may be prosecuted to the fullest extent of the law.

## 1. DESCRIPTION OF EQUIPMENT UNDER TEST (EUT)

General:

Product Name:	TomTom Golfer GPS watch
Brand Name:	TomTom
Model No.:	8RG0
Model difference:	N/A
Hardware Version:	REV.A
Software Version:	0.24.1
USB Dock: (1.0mm)	Model No.: 4UJ0, Supplier: TomTom
Car Charger:	Model No.: 4UUC3Z, Supplier: TomTom
Power Supply:	Battery: 3.7Vdc (0.7Wh) Rechargeable Li-ion Battery

GPS:

Receiver Frequency:	L1 Band, 1575.42MHz
Frequency Conversion oscillator:	26MHz
Antenna Designation:	Ceramic Antenna

This test report applies for GPS function, and complies with *ETSI EN 300 440*

Unless otherwise stated the results shown in this test report refer only to the sample(s) tested and such sample(s) are retained for 90 days only.  
 除非另有說明，此報告結果僅對測試之樣品負責，同時此樣品僅保留90天。本報告未經本公司書面許可，不可部份複製。

This document is issued by the Company subject to its General Conditions of Service printed overleaf, available on request or accessible at [www.sgs.com/terms\\_and\\_conditions.htm](http://www.sgs.com/terms_and_conditions.htm) and, for electronic format documents, subject to Terms and Conditions for Electronic Documents at [www.sgs.com/terms\\_e-document.htm](http://www.sgs.com/terms_e-document.htm). Attention is drawn to the limitation of liability, indemnification and jurisdiction issues defined therein. Any holder of this document is advised that information contained hereon reflects the Company's findings at the time of its intervention only and within the limits of Client's instructions, if any. The Company's sole responsibility is to its Client and this document does not exonerate parties to a transaction from exercising all their rights and obligations under the transaction documents. This document cannot be reproduced except in full, without prior written approval of the Company. Any unauthorized alteration, forgery or falsification of the content or appearance of this document is unlawful and offenders may be prosecuted to the fullest extent of the law.

## 2. DESCRIPTION OF TEST MODES

The EUT has been tested under engineering operating condition. No test engineering mode was used to control the EUT for staying in continuous receiving mode, the channel mid was chosen for testing.

### **The test configuration of position to perform the relevant test:**

The field strength of spurious radiation emission was measured as EUT stand-up position (H mode) and lie down position (E1, E2 mode). The worst-case of H position were reported.

## 3. TEST FACILITY

SGS Taiwan Ltd.

Electronics & Communication Laboratory

No.2, Keji 1st Rd., Guishan Township, Taoyuan County, Taiwan 333

The 11m\*6m\*6m fully anechoic chamber was used for the radiated spurious emissions test.

Unless otherwise stated the results shown in this test report refer only to the sample(s) tested and such sample(s) are retained for 90 days only.

除非另有說明，此報告結果僅對測試之樣品負責，同時此樣品僅保留90天。本報告未經本公司書面許可，不可部份複製。

This document is issued by the Company subject to its General Conditions of Service printed overleaf, available on request or accessible at [www.sgs.com/terms\\_and\\_conditions.htm](http://www.sgs.com/terms_and_conditions.htm) and, for electronic format documents, subject to Terms and Conditions for Electronic Documents at [www.sgs.com/terms\\_e-document.htm](http://www.sgs.com/terms_e-document.htm). Attention is drawn to the limitation of liability, indemnification and jurisdiction issues defined therein. Any holder of this document is advised that information contained hereon reflects the Company's findings at the time of its intervention only and within the limits of Client's instructions, if any. The Company's sole responsibility is to its Client and this document does not exonerate parties to a transaction from exercising all their rights and obligations under the transaction documents. This document cannot be reproduced except in full, without prior written approval of the Company. Any unauthorized alteration, forgery or falsification of the content or appearance of this document is unlawful and offenders may be prosecuted to the fullest extent of the law.



## 4. BLOCK DIAGRAM OF TEST SETUP

Fig. 4-1 Configuration of Tested System

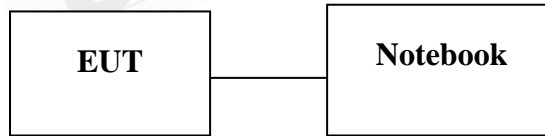

Fig. 4-2 Configuration (Remote Side, on the corner)

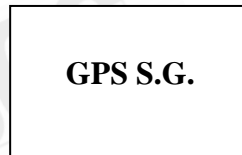

Table 4-1 Support Equipment Used in Tested System

Item	Equipment	Mfr/Brand	Model/Type No.	Series No.	Data Cable	Power Cord
1.	GPS Singal.	WELNAVIGATE	GS-50	607492	N/A	Un-shield
2.	Notebook	Lenovo	L430	PK-0CGFF	shielding	Un-shielding

**Note:** All the above equipment/cables were placed in worse case positions to maximize emission signals during emission test.

**Grounding:** Grounding was in accordance with the manufacturer's requirements and conditions for the intended use.

Unless otherwise stated the results shown in this test report refer only to the sample(s) tested and such sample(s) are retained for 90 days only.  
 除非另有說明，此報告結果僅對測試之樣品負責，同時此樣品僅保留90天。本報告未經本公司書面許可，不可部份複製。

This document is issued by the Company subject to its General Conditions of Service printed overleaf, available on request or accessible at [www.sgs.com/terms\\_and\\_conditions.htm](http://www.sgs.com/terms_and_conditions.htm) and, for electronic format documents, subject to Terms and Conditions for Electronic Documents at [www.sgs.com/terms\\_e-document.htm](http://www.sgs.com/terms_e-document.htm). Attention is drawn to the limitation of liability, indemnification and jurisdiction issues defined therein. Any holder of this document is advised that information contained hereon reflects the Company's findings at the time of its intervention only and within the limits of Client's instructions, if any. The Company's sole responsibility is to its Client and this document does not exonerate parties to a transaction from exercising all their rights and obligations under the transaction documents. This document cannot be reproduced except in full, without prior written approval of the Company. Any unauthorized alteration, forgery or falsification of the content or appearance of this document is unlawful and offenders may be prosecuted to the fullest extent of the law.

## 5. MEASUREMENT UNCERTAINTY

Where relevant, the following measurement uncertainty levels have been calculated in accordance with TR 100 028 [i4]

This uncertainty represents an expanded uncertainty expressed at approximately the 95% confidence level using a coverage factor of  $k=2$ .

This lab's measurement uncertainty  $U_{Lab}$ , is low than Table 10 : Maximum measurement uncertainty of ETSI EN 300 440-1, therefore compliance is deemed to occur if no measured disturbance exceeds the disturbance limit .

Radio frequency	$\pm 2.13 \times 10^{-8}$
RF power (conducted)	$\pm 1.3$ dB
Radiated emission of transmitter, valid between 26,5 GHz	$\pm 4.74$ dB
Radiated emission of receiver, valid to 26,5 GHz	$\pm 4.74$ dB
Temperature	$\pm 0.8$ °C
Humidity	$\pm 4.7$ %
Voltage	$\pm 1$ %
Voltage (AC, < 10 kHz)	$\pm 0.2$ %

Unless otherwise stated the results shown in this test report refer only to the sample(s) tested and such sample(s) are retained for 90 days only.  
 除非另有說明，此報告結果僅對測試之樣品負責，同時此樣品僅保留90天。本報告未經本公司書面許可，不可部份複製。

This document is issued by the Company subject to its General Conditions of Service printed overleaf, available on request or accessible at [www.sgs.com/terms\\_and\\_conditions.htm](http://www.sgs.com/terms_and_conditions.htm) and, for electronic format documents, subject to Terms and Conditions for Electronic Documents at [www.sgs.com/terms\\_e-document.htm](http://www.sgs.com/terms_e-document.htm). Attention is drawn to the limitation of liability, indemnification and jurisdiction issues defined therein. Any holder of this document is advised that information contained hereon reflects the Company's findings at the time of its intervention only and within the limits of Client's instructions, if any. The Company's sole responsibility is to its Client and this document does not exonerate parties to a transaction from exercising all their rights and obligations under the transaction documents. This document cannot be reproduced except in full, without prior written approval of the Company. Any unauthorized alteration, forgery or falsification of the content or appearance of this document is unlawful and offenders may be prosecuted to the fullest extent of the law.



## 6. TRANSMITTER REQUIREMENTS

### 6.1. ETSI EN 300 440-2 Subclause 4.2.1.1: Equivalent Isotropically Radiated Power

#### Measurement Equipment Used:

SGS 1166 Chamber No.A					
Name of Equipment	Manufacturer	Model	Serial Number	Calibration Date	Calibration Due
Spectrum Analyzer	R&S	FSV 40	101059	2014/01/07	2015/01/06
EMI Test Receiver	R&S	ESCI 7	100950	2014/01/11	2015/01/10
Broadband Antenna	TESEQ	CBL 6112D	35243	2014/01/15	2015/01/14
Loop Antenna	ETS-Lindgren	6502	00143303	2014/01/16	2015/01/15
Horn Antenna	ETS-Lindgren	3117	00143279	2014/01/10	2015/01/09
Horn Antenna	Schwarzbeck	BBHA9170	BBHA9170-184	2014/01/23	2015/01/22
Horn Antenna	ETS-Lindgren	3160-09	00117910	2014/01/15	2015/01/14
Horn Antenna	ETS-Lindgren	3160-10	00117782	2014/01/15	2015/01/14
Pre Amplifier	R&S	SCU-18	10195	2014/03/26	2015/03/25
Pre Amplifier	R&S	SCU 26	100778	2014/03/26	2015/03/25
Pre Amplifier	EMC Instruments	EMC330	980163	2014/03/26	2015/03/25
Pre Amplifier	EMC Instruments	EMC184045	980135	2014/01/24	2015/01/23
Signal Generator	R&S	SMR40	100210	2014/01/13	2015/01/12
Signal Generator	R&S	SMC100A	102920	2014/05/21	2015/05/20
Coaxial Cable	Huber+Suhner	RG 214/U	W11.03	2014/03/26	2015/03/25
Coaxial Cable	Huber+Suhner	SUCCOFLEX 104	MY17414/4	2014/03/26	2015/03/25
Coaxial Cable	Huber+Suhner	SUCCOFLEX 104	MY17403/4	2014/03/26	2015/03/25
Coaxial Cable	Huber+Suhner	SUCCOFLEX 104	MY17392/4	2014/03/26	2015/03/25
Coaxial Cable	Huber+Suhner	SUCCOFLEX 104	MY17384/4	2014/03/26	2015/03/25
Coaxial Cable	Huber+Suhner	SUCCOFLEX 104	MY17387/4	2014/03/26	2015/03/25
Attenuator	WOKEN	218FS-10	HY-151	2014/01/06	2015/01/05
Communication Tester	R&S	CMW500	131121	2014/01/16	2015/01/15
Communication Tester	Anritsu	MT8820C	6201107337	2014/04/23	2015/04/22
Controller	MF	MF-7802	N/A	N.C.R.	N.C.R.
Antenna Master	MF	N/A	N/A	N.C.R.	N.C.R.
Turn Table	MF	N/A	N/A	N.C.R.	N.C.R.
Test Software	World-Pallas	Dr. E	V 3.0 Lite	N.C.R.	N.C.R.

Unless otherwise stated the results shown in this test report refer only to the sample(s) tested and such sample(s) are retained for 90 days only.  
 除非另有說明，此報告結果僅對測試之樣品負責，同時此樣品僅保留90天。本報告未經本公司書面許可，不可部份複製。

This document is issued by the Company subject to its General Conditions of Service printed overleaf, available on request or accessible at [www.sgs.com/terms\\_and\\_conditions.htm](http://www.sgs.com/terms_and_conditions.htm) and, for electronic format documents, subject to Terms and Conditions for Electronic Documents at [www.sgs.com/terms\\_e-document.htm](http://www.sgs.com/terms_e-document.htm). Attention is drawn to the limitation of liability, indemnification and jurisdiction issues defined therein. Any holder of this document is advised that information contained hereon reflects the Company's findings at the time of its intervention only and within the limits of Client's instructions, if any. The Company's sole responsibility is to its Client and this document does not exonerate parties to a transaction from exercising all their rights and obligations under the transaction documents. This document cannot be reproduced except in full, without prior written approval of the Company. Any unauthorized alteration, forgery or falsification of the content or appearance of this document is unlawful and offenders may be prosecuted to the fullest extent of the law.

## Test Setup:

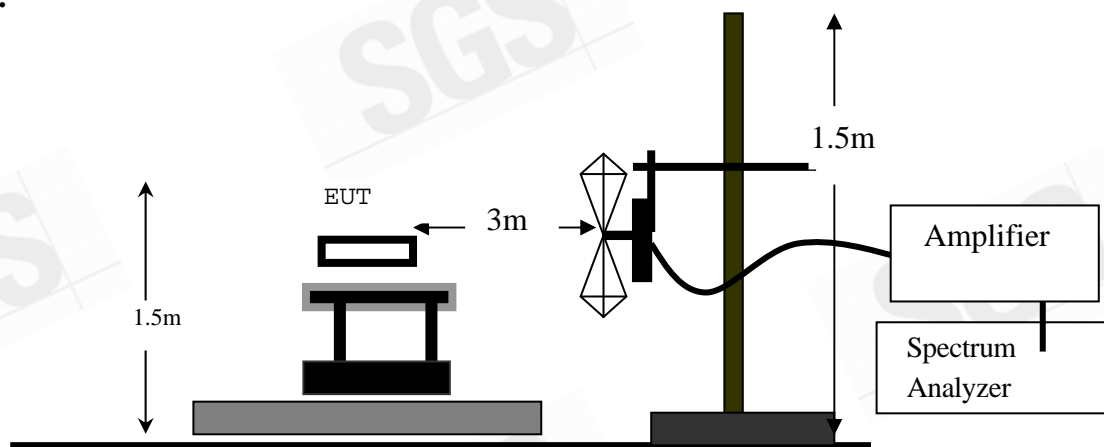

## SUBSTITUTION METHOD: (Radiated Emissions)

### Radiated below 1GHz

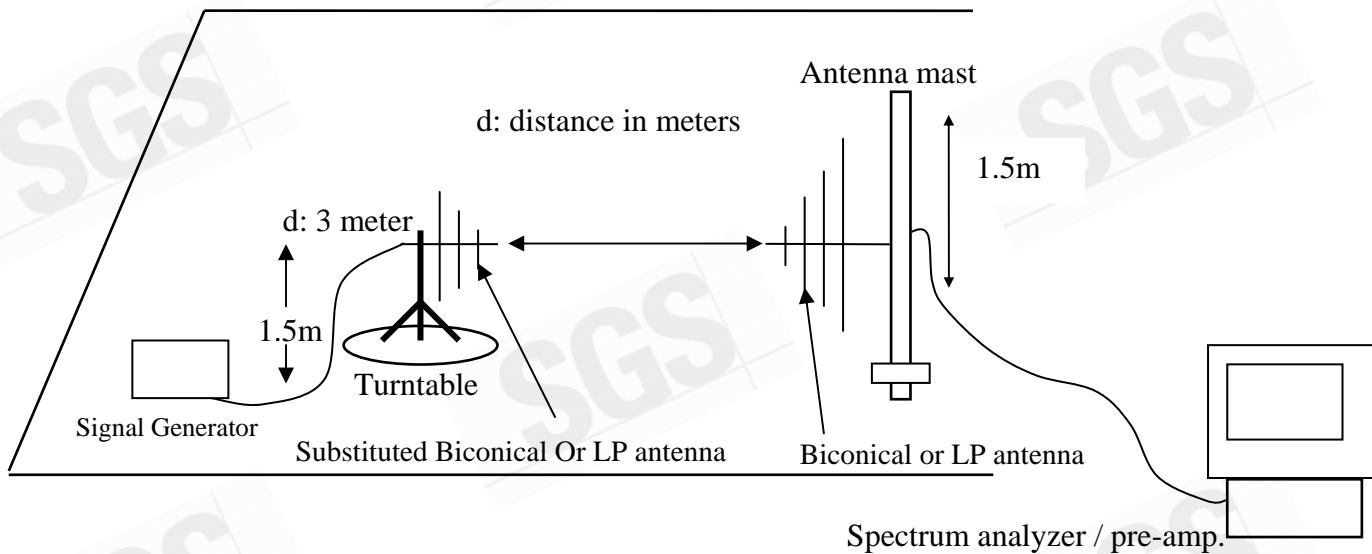

Unless otherwise stated the results shown in this test report refer only to the sample(s) tested and such sample(s) are retained for 90 days only.  
 除非另有說明，此報告結果僅對測試之樣品負責，同時此樣品僅保留90天。本報告未經本公司書面許可，不可部份複製。

This document is issued by the Company subject to its General Conditions of Service printed overleaf, available on request or accessible at [www.sgs.com/terms\\_and\\_conditions.htm](http://www.sgs.com/terms_and_conditions.htm) and, for electronic format documents, subject to Terms and Conditions for Electronic Documents at [www.sgs.com/terms\\_e-document.htm](http://www.sgs.com/terms_e-document.htm). Attention is drawn to the limitation of liability, indemnification and jurisdiction issues defined therein. Any holder of this document is advised that information contained hereon reflects the Company's findings at the time of its intervention only and within the limits of Client's instructions, if any. The Company's sole responsibility is to its Client and this document does not exonerate parties to a transaction from exercising all their rights and obligations under the transaction documents. This document cannot be reproduced except in full, without prior written approval of the Company. Any unauthorized alteration, forgery or falsification of the content or appearance of this document is unlawful and offenders may be prosecuted to the fullest extent of the law.

## Radiated above 1 GHz

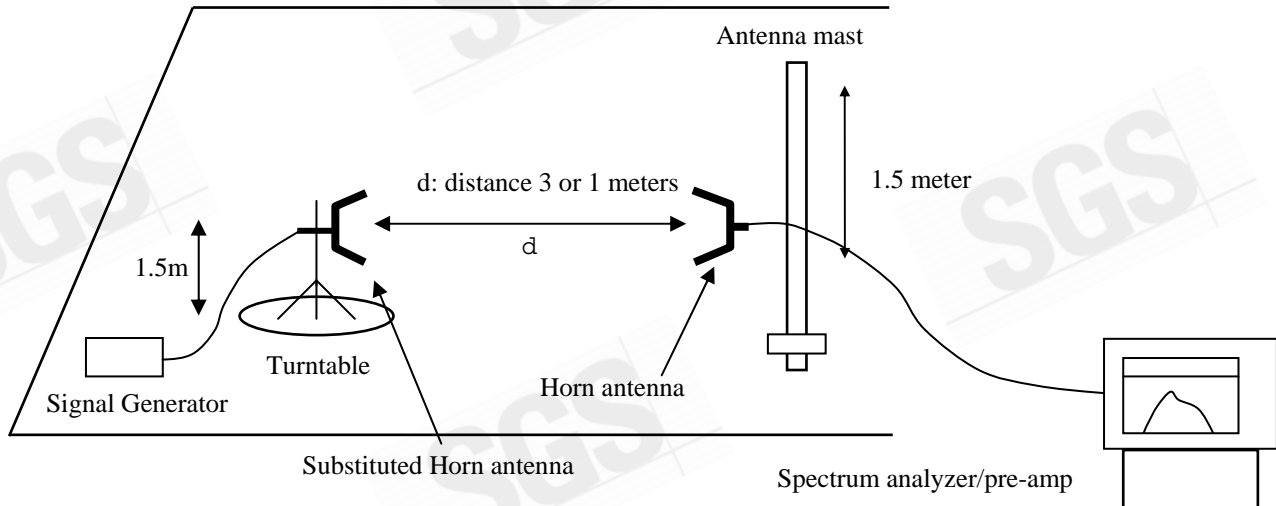

### Minimum requirement:

### ETSI EN 300 440-1[V1.6.1] Subclause 7.1.3 Limits:

Table 4: Maximum radiated peak power (e.i.r.p.)

Frequency Bands	Power	Application	Notes
2 400 MHz to 2 483,5 MHz	10 mW e.i.r.p.	Generic use	
2 400 MHz to 2 483,5 MHz	25 mW e.i.r.p.	Detection, movement and alert applications	
(a) 2 446 MHz to 2 454 MHz	500 mW e.i.r.p.	RFID	See also table 7 and annex C
(b) 2 446 MHz to 2 454 MHz	4 W e.i.r.p.	RFID	See also table 7 and annex C
5 725 MHz to 5 875 MHz	25 mW e.i.r.p.	Generic use	
9 200 MHz to 9 500 MHz	25 mW e.i.r.p.	Detection, movement and alert applications	
9 500 MHz to 9 975 MHz	25 mW e.i.r.p.	Detection, movement and alert applications	
10,5 GHz to 10,6 GHz	25 mW e.i.r.p.	Detection, movement and alert applications	
13,4 GHz to 14,0 GHz	25 mW e.i.r.p.	Detection, movement and alert applications	
17,1 GHz to 17,3 GHz	400 mW e.i.r.p.	GBSAR detection, movement and alert applications	See annex E
24,00 GHz to 24,25 GHz	100 mW e.i.r.p.	Generic use and detection, movement and alert applications	

Unless otherwise stated the results shown in this test report refer only to the sample(s) tested and such sample(s) are retained for 90 days only.  
 除非另有說明，此報告結果僅對測試之樣品負責，同時此樣品僅保留90天。本報告未經本公司書面許可，不可部份複製。

This document is issued by the Company subject to its General Conditions of Service printed overleaf, available on request or accessible at [www.sgs.com/terms\\_and\\_conditions.htm](http://www.sgs.com/terms_and_conditions.htm) and, for electronic format documents, subject to Terms and Conditions for Electronic Documents at [www.sgs.com/terms\\_e-document.htm](http://www.sgs.com/terms_e-document.htm). Attention is drawn to the limitation of liability, indemnification and jurisdiction issues defined therein. Any holder of this document is advised that information contained hereon reflects the Company's findings at the time of its intervention only and within the limits of Client's instructions, if any. The Company's sole responsibility is to its Client and this document does not exonerate parties to a transaction from exercising all their rights and obligations under the transaction documents. This document cannot be reproduced except in full, without prior written approval of the Company. Any unauthorized alteration, forgery or falsification of the content or appearance of this document is unlawful and offenders may be prosecuted to the fullest extent of the law.

**Test Procedure:**

EUT was placed on an 1.5m outdoor wooden table. The search antenna is placed at 3m distance from the EUT and search antenna height is from 1.5m. With the transmitter operating at continuously mode, the turntable was slowly rotated to locate the direction of maximum emission. Once maximum direction is determined, the search antenna was raised and lowered in both vertical and horizontal polarizations.

The EUT was removed from the turntable and replaced with a linearly polarized antenna connected to a calibrated RF signal generator. The RF generator was set to a measured emission frequency and the search antenna was raised and lowered to produce a maximum received reading. The generator output was increased to match the radiated emission reading measured previously, and the result expressed in dB E.I.R.P. or ERP.

**Test results: N/A**

Unless otherwise stated the results shown in this test report refer only to the sample(s) tested and such sample(s) are retained for 90 days only.  
除非另有說明，此報告結果僅對測試之樣品負責，同時此樣品僅保留90天。本報告未經本公司書面許可，不可部份複製。

This document is issued by the Company subject to its General Conditions of Service printed overleaf, available on request or accessible at [www.sgs.com/terms\\_and\\_conditions.htm](http://www.sgs.com/terms_and_conditions.htm) and, for electronic format documents, subject to Terms and Conditions for Electronic Documents at [www.sgs.com/terms\\_e-document.htm](http://www.sgs.com/terms_e-document.htm). Attention is drawn to the limitation of liability, indemnification and jurisdiction issues defined therein. Any holder of this document is advised that information contained hereon reflects the Company's findings at the time of its intervention only and within the limits of Client's instructions, if any. The Company's sole responsibility is to its Client and this document does not exonerate parties to a transaction from exercising all their rights and obligations under the transaction documents. This document cannot be reproduced except in full, without prior written approval of the Company. Any unauthorized alteration, forgery or falsification of the content or appearance of this document is unlawful and offenders may be prosecuted to the fullest extent of the law.

**6.2. ETSI EN 300 440-2 Subclause 4.2.1.2: Permitted Range of operating Frequencies CEPT/ERC Recommendation 70-03.** Limit, the frequency range shall lie within the frequency band allocated 2400MHz –2483.5MHz

**Measurement Equipment Used: Same as**

SGS Conducted Room					
Name of Equipment	Manufacturer	Model	Serial Number	Calibration Date	Calibration Due
Spectrum Analyzer	Agilent	N9010A	MY53400256	2013/10/26	2014/10/25
Power Meter	Anritsu	ML2496A	1326001	2014/06/20	2015/06/19
Power Sensor	Anritsu	MA2411B	1315048	2014/06/20	2015/06/19
Power Sensor	Anritsu	MA2411B	1315049	2014/06/20	2015/06/19
Coaxial Cable 30cm	WOKEN	00100A1F1A195C	2	2014/01/06	2015/01/05
Coaxial Cable 30cm	WOKEN	00100A1F1A195C	3	2014/01/06	2015/01/05
Coaxial Cable 80cm	WOKEN	00100A1F1A185C	1	2014/01/06	2015/01/05
DC Block	Mini-Circuits	BLK-18-S+	4	2014/01/06	2015/01/05
DC Block	PASTERNAK	PE8210	5	2014/01/06	2015/01/05
Splitter	RF-LAMBAD	RFLT2W1G18G	11-JSPF412-019	2014/01/06	2015/01/05
Splitter	WOKEN	NA	DOM35LW1A2	2014/01/06	2015/01/05
Attenuator	Mini-Circuits	BW-S10W2+	6	2014/01/06	2015/01/05
Attenuator	WOKEN	218FS-10	7	2014/01/06	2015/01/05
Temperature Chamber	TERCHY	MHK-120LK	1020582	2014/06/18	2015/06/17
Communication Tester	R&S	CMW500	131121	2014/01/16	2015/01/15
Communication Tester	Anritsu	MT8820C	6201107337	2014/04/24	2015/04/23
DC Power Supply	Agilent	E3640A	MY53140006	2014/05/31	2015/05/30
DC Power Supply	Agilent	E3640A	MY53130054	2014/05/21	2015/05/20

Unless otherwise stated the results shown in this test report refer only to the sample(s) tested and such sample(s) are retained for 90 days only.  
 除非另有說明，此報告結果僅對測試之樣品負責，同時此樣品僅保留90天。本報告未經本公司書面許可，不可部份複製。

This document is issued by the Company subject to its General Conditions of Service printed overleaf, available on request or accessible at [www.sgs.com/terms\\_and\\_conditions.htm](http://www.sgs.com/terms_and_conditions.htm) and, for electronic format documents, subject to Terms and Conditions for Electronic Documents at [www.sgs.com/terms\\_e-document.htm](http://www.sgs.com/terms_e-document.htm). Attention is drawn to the limitation of liability, indemnification and jurisdiction issues defined therein. Any holder of this document is advised that information contained hereon reflects the Company's findings at the time of its intervention only and within the limits of Client's instructions, if any. The Company's sole responsibility is to its Client and this document does not exonerate parties to a transaction from exercising all their rights and obligations under the transaction documents. This document cannot be reproduced except in full, without prior written approval of the Company. Any unauthorized alteration, forgery or falsification of the content or appearance of this document is unlawful and offenders may be prosecuted to the fullest extent of the law.

## Test Setup:

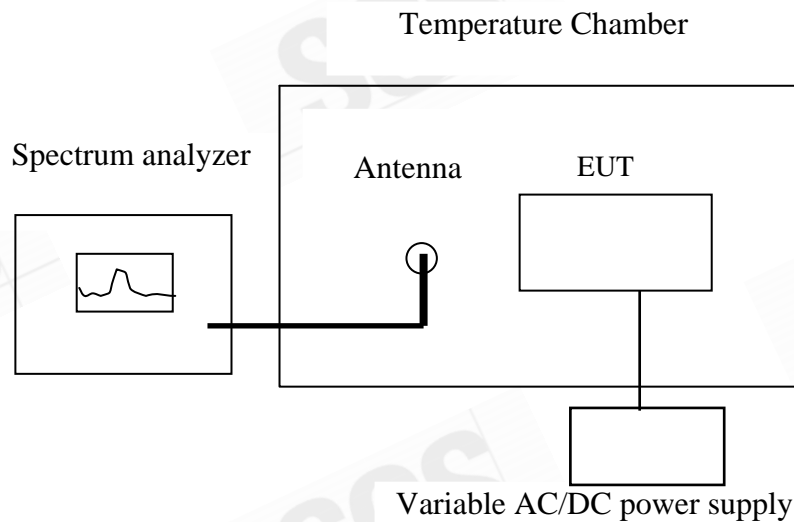

## Test Procedure:

1. Put the spectrum analyzer in video averaging mode with a minimum of 50 sweeps selected.
2. Select the lowest operating frequency of the equipment under test and activate the transmitter with modulation applied.
3. Using the marker of the spectrum analyzer, find lowest and highest frequency at which the spectral power density drops below the level of  $-74.8$  dBm/Hz spectral power density ( $-30$ dBm if measured in a 30KHz bandwidth) EIRP, those frequencies were recorded in the test report.
4. The difference between the frequencies is the operating frequency range. Recorded in the test report.

Test results: N/A

Unless otherwise stated the results shown in this test report refer only to the sample(s) tested and such sample(s) are retained for 90 days only.  
 除非另有說明，此報告結果僅對測試之樣品負責，同時此樣品僅保留90天。本報告未經本公司書面許可，不可部份複製。

This document is issued by the Company subject to its General Conditions of Service printed overleaf, available on request or accessible at [www.sgs.com/terms\\_and\\_conditions.htm](http://www.sgs.com/terms_and_conditions.htm) and, for electronic format documents, subject to Terms and Conditions for Electronic Documents at [www.sgs.com/terms\\_e-document.htm](http://www.sgs.com/terms_e-document.htm). Attention is drawn to the limitation of liability, indemnification and jurisdiction issues defined therein. Any holder of this document is advised that information contained hereon reflects the Company's findings at the time of its intervention only and within the limits of Client's instructions, if any. The Company's sole responsibility is to its Client and this document does not exonerate parties to a transaction from exercising all their rights and obligations under the transaction documents. This document cannot be reproduced except in full, without prior written approval of the Company. Any unauthorized alteration, forgery or falsification of the content or appearance of this document is unlawful and offenders may be prosecuted to the fullest extent of the law.



### 6.3. ETSI EN 300 440-2 Subclause 4.2.1.3: Spurious Emissions of Transmitter

Measurement Equipment Used: Same as Subclause 4.2.1.1: Equivalent Isotropically Radiated Power

Measuring receiver:

Frequency range: (f)	Measuring receiver bandwidth
$30 \text{ MHz} \leq f \leq 1\,000 \text{ MHz}$	100 kHz to 120 kHz
$f > 1\,000 \text{ MHz}$	1 MHz

Test Setup: Same as Subclause 4.2.1.1: Equivalent Isotropically Radiated Power

Substitution Method: Radiated Emissions

Minimum requirement:

**ETSI EN 300 440-1[V1.6.1] Subclause 7.3.6 Limits:** The power of any spurious emission shall not exceed the following values given in table

Frequency ranges	47 MHz to 74 MHz 87,5 MHz to 108 MHz 174 MHz to 230 MHz 470 MHz to 862 MHz	Other frequencies $\leq 1\,000 \text{ MHz}$	Frequencies $> 1\,000 \text{ MHz}$
State			
Operating	4 nW	250 nW	1 $\mu\text{W}$
Standby	2 nW	2 nW	20 nW

Test Procedure: Same as Subclause 4.2.1.1: Equivalent Isotropically Radiated Power

Test results: N/A

**ETSI EN 300 440-2 Subclause 4.2.1.4: Duty Cycle**

N/A

Unless otherwise stated the results shown in this test report refer only to the sample(s) tested and such sample(s) are retained for 90 days only.  
除非另有說明，此報告結果僅對測試之樣品負責，同時此樣品僅保留90天。本報告未經本公司書面許可，不可部份複製。

This document is issued by the Company subject to its General Conditions of Service printed overleaf, available on request or accessible at [www.sgs.com/terms\\_and\\_conditions.htm](http://www.sgs.com/terms_and_conditions.htm) and, for electronic format documents, subject to Terms and Conditions for Electronic Documents at [www.sgs.com/terms\\_e-document.htm](http://www.sgs.com/terms_e-document.htm). Attention is drawn to the limitation of liability, indemnification and jurisdiction issues defined therein. Any holder of this document is advised that information contained hereon reflects the Company's findings at the time of its intervention only and within the limits of Client's instructions, if any. The Company's sole responsibility is to its Client and this document does not exonerate parties to a transaction from exercising all their rights and obligations under the transaction documents. This document cannot be reproduced except in full, without prior written approval of the Company. Any unauthorized alteration, forgery or falsification of the content or appearance of this document is unlawful and offenders may be prosecuted to the fullest extent of the law.

**Receiver Requirements**

**ETSI EN 300 440-1 Subclause 4.1.1: Receiver classification**

Receiver category	Relevant receiver clauses	Risk assessment of receiver performance
1	8.1, 8.2 and 8.3	Highly reliable SRD communication media; e.g. serving human life inherent systems (may result in a physical risk to a person).
2	8.2 and 8.3	Medium reliable SRD communication media e.g. causing inconvenience to persons, which cannot simply be overcome by other means.
3	8.3	Standard reliable SRD communication media e.g. Inconvenience to persons, which can simply be overcome by other means (e.g. manual).

**This device is a class 3 device.**

**6.4. ETSI EN 300 440-2 Subclause 4.2.2.1: The Adjacent channel selectivity-in-band**

**This requirement applies to Equipment Class 1 receiver, N/A. This device is a class 3 device.**

**6.5. ETSI EN 300 440-2 Subclause 4.2.2.2: Blocking or desensitization**

**This requirement applies to Equipment Class 1 and 2 receivers, N/A. This device is a class 3 device.**

**6.6. ETSI EN 300 440-2 Subclause 4.2.2.3: Spurious Emissions**

**Measurement Equipment Used: Same as Subclause 4.1.1: Equivalent Isotropically Radiated Power**

**Test Setup: Same as Subclause 4.1.1: Equivalent Isotropically Radiated Power**

**SUBSTITUTION METHOD: Radiated Emissions**

**Minimum requirement:**

**ETSI EN 300 440-1[V1.6.1] Subclause 8.3.5 Limits:** The power of any spurious emission, conducted or radiated, shall not exceed the following values given in table 13 below.

	Below 1000MHz	Above 1000MHz
<b>Operating</b>	<b>2 nW</b>	<b>20 nW</b>

Unless otherwise stated the results shown in this test report refer only to the sample(s) tested and such sample(s) are retained for 90 days only.  
 除非另有說明，此報告結果僅對測試之樣品負責，同時此樣品僅保留90天。本報告未經本公司書面許可，不可部份複製。

This document is issued by the Company subject to its General Conditions of Service printed overleaf, available on request or accessible at [www.sgs.com/terms\\_and\\_conditions.htm](http://www.sgs.com/terms_and_conditions.htm) and, for electronic format documents, subject to Terms and Conditions for Electronic Documents at [www.sgs.com/terms\\_e-document.htm](http://www.sgs.com/terms_e-document.htm). Attention is drawn to the limitation of liability, indemnification and jurisdiction issues defined therein. Any holder of this document is advised that information contained hereon reflects the Company's findings at the time of its intervention only and within the limits of Client's instructions, if any. The Company's sole responsibility is to its Client and this document does not exonerate parties to a transaction from exercising all their rights and obligations under the transaction documents. This document cannot be reproduced except in full, without prior written approval of the Company. Any unauthorized alteration, forgery or falsification of the content or appearance of this document is unlawful and offenders may be prosecuted to the fullest extent of the law.

## Test Procedure:

EUT was placed on a 1.5m outdoor wooden table. The search antenna is placed at 3m distances from the EUT and search antenna height is from 1.5m. With the transmitter operating at continuously mode, the turntable was slowly rotated to locate the direction of maximum emission. Once maximum direction is determined, the search antenna was raised and lowered in both vertical and horizontal polarizations.

The EUT was removed from the turntable and replaced with a linearly polarized antenna connected to a calibrated RF signal generator. The RF generator was set to a measured emission frequency and the search antenna was raised and lowered to produce a maximum received reading. The generator output was increased to match the radiated emission reading measured previously, and the result expressed in dB EIRP or ERP, correcting for substitution antenna gain at each frequency.

Unless otherwise stated the results shown in this test report refer only to the sample(s) tested and such sample(s) are retained for 90 days only.  
除非另有說明，此報告結果僅對測試之樣品負責，同時此樣品僅保留90天。本報告未經本公司書面許可，不可部份複製。

This document is issued by the Company subject to its General Conditions of Service printed overleaf, available on request or accessible at [www.sgs.com/terms\\_and\\_conditions.htm](http://www.sgs.com/terms_and_conditions.htm) and, for electronic format documents, subject to Terms and Conditions for Electronic Documents at [www.sgs.com/terms\\_e-document.htm](http://www.sgs.com/terms_e-document.htm). Attention is drawn to the limitation of liability, indemnification and jurisdiction issues defined therein. Any holder of this document is advised that information contained hereon reflects the Company's findings at the time of its intervention only and within the limits of Client's instructions, if any. The Company's sole responsibility is to its Client and this document does not exonerate parties to a transaction from exercising all their rights and obligations under the transaction documents. This document cannot be reproduced except in full, without prior written approval of the Company. Any unauthorized alteration, forgery or falsification of the content or appearance of this document is unlawful and offenders may be prosecuted to the fullest extent of the law.

**Test results:**

Operation Band	:GPS	Test Date	:2014-08-14
ARFCN	:	Temp./Humi.	:23.6deg_C / 60 RH
Fundamental Frequency	:1575.42 MHz	Engineer	:Aken
Operation Mode	:RX		
EUT Pol.	:E2 Plan	Measurement Antenna Pol.	:VERTICAL

EIRP(dBm) = SG Level(dBm) + Antenna Gain(dBi) - Cable Loss(dB)

Note : "F" : denotes Fundamental Frequency. ; "H" : denotes Harmonic Frequency.

"E" : denotes Band Edge Frequency. ; "S" : denotes Spurious Frequency.

Freq.	Note	EIRP	SG	Antenna	Cable	Limit	Margin
MHz	F/H/E/S	dBm	Output Level dBm	Gain dBi	Loss dB	dBm	dB
38.73	S	-68.36	-46.57	-20.96	0.83	-57.00	-11.36
79.47	S	-73.09	-69.14	-2.74	1.21	-57.00	-16.09
199.75	S	-75.26	-73.94	0.68	2.00	-57.00	-18.26
396.66	S	-73.45	-70.91	0.41	2.94	-57.00	-16.45
480.08	S	-68.61	-64.82	-0.54	3.24	-57.00	-11.61
846.74	S	-74.56	-68.25	-1.93	4.39	-57.00	-17.56
3150.84	H	-56.79	-56.56	7.30	7.54	-47.00	-9.79
4726.26	H	-	-	-	-	-	-
6301.68	H	-	-	-	-	-	-
7877.10	H	-	-	-	-	-	-
9452.52	H	-	-	-	-	-	-
11027.94	H	-	-	-	-	-	-
12603.36	H	-	-	-	-	-	-

Unless otherwise stated the results shown in this test report refer only to the sample(s) tested and such sample(s) are retained for 90 days only.

除非另有說明，此報告結果僅對測試之樣品負責，同時此樣品僅保留90天。本報告未經本公司書面許可，不可部份複製。

This document is issued by the Company subject to its General Conditions of Service printed overleaf, available on request or accessible at [www.sgs.com/terms\\_and\\_conditions.htm](http://www.sgs.com/terms_and_conditions.htm) and, for electronic format documents, subject to Terms and Conditions for Electronic Documents at [www.sgs.com/terms\\_e-document.htm](http://www.sgs.com/terms_e-document.htm). Attention is drawn to the limitation of liability, indemnification and jurisdiction issues defined therein. Any holder of this document is advised that information contained hereon reflects the Company's findings at the time of its intervention only and within the limits of Client's instructions, if any. The Company's sole responsibility is to its Client and this document does not exonerate parties to a transaction from exercising all their rights and obligations under the transaction documents. This document cannot be reproduced except in full, without prior written approval of the Company. Any unauthorized alteration, forgery or falsification of the content or appearance of this document is unlawful and offenders may be prosecuted to the fullest extent of the law.

Operation Band	:GPS	Test Date	:2014-08-14
ARFCN	:	Temp./Humi.	:23.6deg_C / 60 RH
Fundamental Frequency	:1575.42 MHz	Engineer	:Aken
Operation Mode	:RX		
EUT Pol.	:E2 Plan	Measurement Antenna Pol.	:HORIZONTAL

EIRP(dBm) = SG Level(dBm) + Antenna Gain(dBi) - Cable Loss(dB)

Note : "F" : denotes Fundamental Frequency. ; "H" : denotes Harmonic Frequency.

"E" : denotes Band Edge Frequency. ; "S" : denotes Spurious Frequency.

Freq. MHz	Note F/H/E/S	EIRP dBm	SG Output Level dBm	Antenna Gain dBi	Cable Loss dB	Limit dBm	Margin dB
80.44	S	-68.19	-64.42	-2.56	1.21	-57.00	-11.19
149.31	S	-64.40	-61.13	-1.53	1.74	-57.00	-7.40
204.60	S	-72.06	-70.73	0.70	2.03	-57.00	-15.06
480.08	S	-65.97	-62.18	-0.54	3.24	-57.00	-8.97
528.58	S	-73.07	-68.82	-0.93	3.32	-57.00	-16.07
845.77	S	-74.06	-67.78	-1.93	4.34	-57.00	-17.06
3150.84	H	-56.01	-55.77	7.30	7.54	-47.00	-9.01
4726.26	H	-	-	-	-	-	-
6301.68	H	-	-	-	-	-	-
7877.10	H	-	-	-	-	-	-
9452.52	H	-	-	-	-	-	-
11027.94	H	-	-	-	-	-	-
12603.36	H	-	-	-	-	-	-

Unless otherwise stated the results shown in this test report refer only to the sample(s) tested and such sample(s) are retained for 90 days only.

除非另有說明，此報告結果僅對測試之樣品負責，同時此樣品僅保留90天。本報告未經本公司書面許可，不可部份複製。

This document is issued by the Company subject to its General Conditions of Service printed overleaf, available on request or accessible at [www.sgs.com/terms\\_and\\_conditions.htm](http://www.sgs.com/terms_and_conditions.htm) and, for electronic format documents, subject to Terms and Conditions for Electronic Documents at [www.sgs.com/terms\\_e-document.htm](http://www.sgs.com/terms_e-document.htm). Attention is drawn to the limitation of liability, indemnification and jurisdiction issues defined therein. Any holder of this document is advised that information contained hereon reflects the Company's findings at the time of its intervention only and within the limits of Client's instructions, if any. The Company's sole responsibility is to its Client and this document does not exonerate parties to a transaction from exercising all their rights and obligations under the transaction documents. This document cannot be reproduced except in full, without prior written approval of the Company. Any unauthorized alteration, forgery or falsification of the content or appearance of this document is unlawful and offenders may be prosecuted to the fullest extent of the law.

### 6.7. ETSI EN 300 440-2 Subclause 6: Interpretation of Measurement Results

All the measurement equipments and accessories have been carefully selected to meet the maximum measurement uncertainty specified below:

Parameters	Uncertainty
Radio frequency	$\pm 1 \times 10^{-7}$
RF power (conducted)	$\pm 2,5$ dB
Radiated emission of transmitter, valid to 26,5 GHz	$\pm 6$ dB
Radiated emission of transmitter, valid between 26,5 GHz and 66 GHz	$\pm 8$ dB
Radiated emission of receiver, valid to 26,5 GHz	$\pm 6$ dB
Radiated emission of receiver, valid between 26,5 GHz and 66 GHz	$\pm 8$ dB
Temperature	$\pm 1$ °C
Humidity	$\pm 5$ %
Voltage (DC)	$\pm 1$ %
Voltage (AC, < 10 kHz)	$\pm 2$ %
NOTE: For radiated emissions above 26,5 GHz it may not be possible to achieve measurement uncertainties complying with the levels specified in this table. In these cases alone it is acceptable to employ the alternative interpretation procedure specified in clause 10.1.	

P.S. For the test methods, according to the present document the uncertainty figures shall be calculated according to the methods described in the TR 100 028 [i.4] and shall correspond to an expansion factor (coverage factor)  $k = 1,96$  or  $k = 2$  (which provide confidence levels of respectively 95 % and 95,45 % in case where the distributions characterizing the actual measurement uncertainties are normal (Gaussian)).

Table 10 is based on such expansion factors.

The particular expansion factor used for the evaluation of the measurement uncertainty shall be stated.

Unless otherwise stated the results shown in this test report refer only to the sample(s) tested and such sample(s) are retained for 90 days only.  
 除非另有說明，此報告結果僅對測試之樣品負責，同時此樣品僅保留90天。本報告未經本公司書面許可，不可部份複製。

This document is issued by the Company subject to its General Conditions of Service printed overleaf, available on request or accessible at [www.sgs.com/terms\\_and\\_conditions.htm](http://www.sgs.com/terms_and_conditions.htm) and, for electronic format documents, subject to Terms and Conditions for Electronic Documents at [www.sgs.com/terms\\_e-document.htm](http://www.sgs.com/terms_e-document.htm). Attention is drawn to the limitation of liability, indemnification and jurisdiction issues defined therein. Any holder of this document is advised that information contained hereon reflects the Company's findings at the time of its intervention only and within the limits of Client's instructions, if any. The Company's sole responsibility is to its Client and this document does not exonerate parties to a transaction from exercising all their rights and obligations under the transaction documents. This document cannot be reproduced except in full, without prior written approval of the Company. Any unauthorized alteration, forgery or falsification of the content or appearance of this document is unlawful and offenders may be prosecuted to the fullest extent of the law.



# APPENDIX 1

## PHOTOGRAPHS OF TEST SETUP

Unless otherwise stated the results shown in this test report refer only to the sample(s) tested and such sample(s) are retained for 90 days only.

除非另有說明，此報告結果僅對測試之樣品負責，同時此樣品僅保留90天。本報告未經本公司書面許可，不可部份複製。

This document is issued by the Company subject to its General Conditions of Service printed overleaf, available on request or accessible at [www.sgs.com/terms\\_and\\_conditions.htm](http://www.sgs.com/terms_and_conditions.htm) and, for electronic format documents, subject to Terms and Conditions for Electronic Documents at [www.sgs.com/terms\\_e-document.htm](http://www.sgs.com/terms_e-document.htm). Attention is drawn to the limitation of liability, indemnification and jurisdiction issues defined therein. Any holder of this document is advised that information contained hereon reflects the Company's findings at the time of its intervention only and within the limits of Client's instructions, if any. The Company's sole responsibility is to its Client and this document does not exonerate parties to a transaction from exercising all their rights and obligations under the transaction documents. This document cannot be reproduced except in full, without prior written approval of the Company. Any unauthorized alteration, forgery or falsification of the content or appearance of this document is unlawful and offenders may be prosecuted to the fullest extent of the law.

## Radiated Emission Set up Photos (E2 PLAN) (Below 1GHz)



*Back View of Set up*



Unless otherwise stated the results shown in this test report refer only to the sample(s) tested and such sample(s) are retained for 90 days only.

除非另有說明，此報告結果僅對測試之樣品負責，同時此樣品僅保留90天。本報告未經本公司書面許可，不可部份複製。

This document is issued by the Company subject to its General Conditions of Service printed overleaf, available on request or accessible at [www.sgs.com/terms\\_and\\_conditions.htm](http://www.sgs.com/terms_and_conditions.htm) and, for electronic format documents, subject to Terms and Conditions for Electronic Documents at [www.sgs.com/terms\\_e-document.htm](http://www.sgs.com/terms_e-document.htm). Attention is drawn to the limitation of liability, indemnification and jurisdiction issues defined therein. Any holder of this document is advised that information contained hereon reflects the Company's findings at the time of its intervention only and within the limits of Client's instructions, if any. The Company's sole responsibility is to its Client and this document does not exonerate parties to a transaction from exercising all their rights and obligations under the transaction documents. This document cannot be reproduced except in full, without prior written approval of the Company. Any unauthorized alteration, forgery or falsification of the content or appearance of this document is unlawful and offenders may be prosecuted to the fullest extent of the law.

## Radiated Emission Set up Photos (E2 PLAN) (Above 1GHz)



*Back View of Set up*

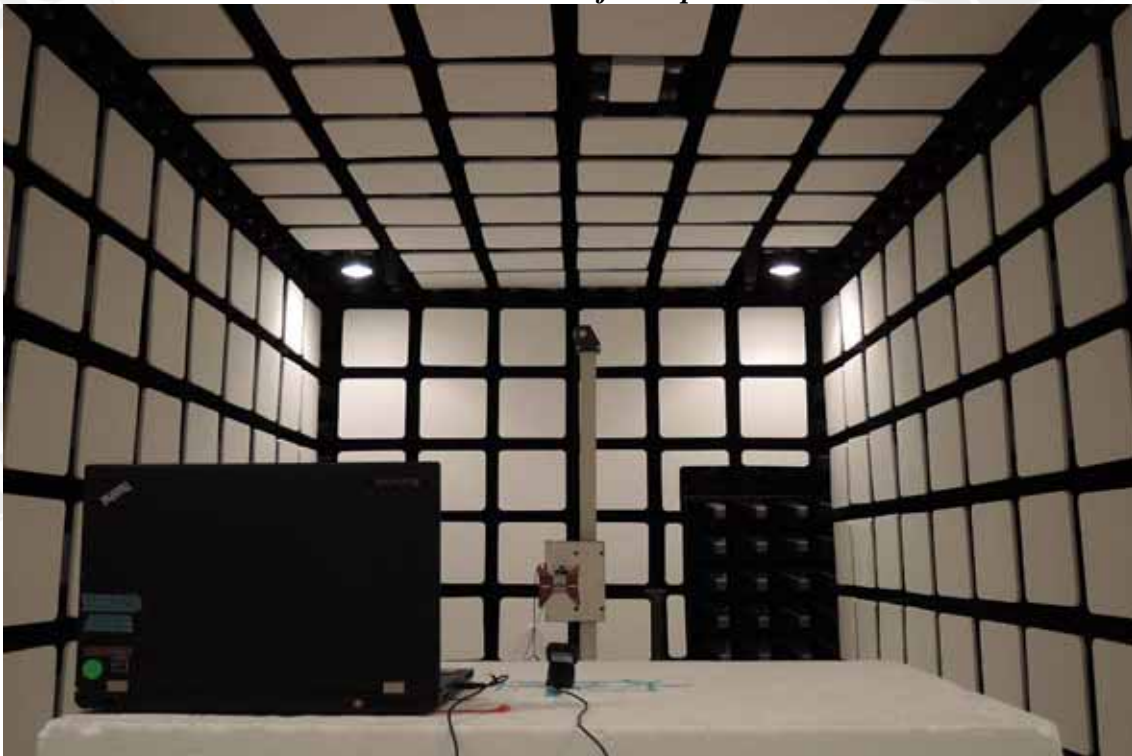

Unless otherwise stated the results shown in this test report refer only to the sample(s) tested and such sample(s) are retained for 90 days only.  
 除非另有說明，此報告結果僅對測試之樣品負責，同時此樣品僅保留90天。本報告未經本公司書面許可，不可部份複製。

This document is issued by the Company subject to its General Conditions of Service printed overleaf, available on request or accessible at [www.sgs.com/terms\\_and\\_conditions.htm](http://www.sgs.com/terms_and_conditions.htm) and, for electronic format documents, subject to Terms and Conditions for Electronic Documents at [www.sgs.com/terms\\_e-document.htm](http://www.sgs.com/terms_e-document.htm). Attention is drawn to the limitation of liability, indemnification and jurisdiction issues defined therein. Any holder of this document is advised that information contained hereon reflects the Company's findings at the time of its intervention only and within the limits of Client's instructions, if any. The Company's sole responsibility is to its Client and this document does not exonerate parties to a transaction from exercising all their rights and obligations under the transaction documents. This document cannot be reproduced except in full, without prior written approval of the Company. Any unauthorized alteration, forgery or falsification of the content or appearance of this document is unlawful and offenders may be prosecuted to the fullest extent of the law.

## APPENDIX 2

### PHOTOGRAPHS OF EUT

Unless otherwise stated the results shown in this test report refer only to the sample(s) tested and such sample(s) are retained for 90 days only.

除非另有說明，此報告結果僅對測試之樣品負責，同時此樣品僅保留90天。本報告未經本公司書面許可，不可部份複製。

This document is issued by the Company subject to its General Conditions of Service printed overleaf, available on request or accessible at [www.sgs.com/terms\\_and\\_conditions.htm](http://www.sgs.com/terms_and_conditions.htm) and, for electronic format documents, subject to Terms and Conditions for Electronic Documents at [www.sgs.com/terms\\_e-document.htm](http://www.sgs.com/terms_e-document.htm). Attention is drawn to the limitation of liability, indemnification and jurisdiction issues defined therein. Any holder of this document is advised that information contained hereon reflects the Company's findings at the time of its intervention only and within the limits of Client's instructions, if any. The Company's sole responsibility is to its Client and this document does not exonerate parties to a transaction from exercising all their rights and obligations under the transaction documents. This document cannot be reproduced except in full, without prior written approval of the Company. Any unauthorized alteration, forgery or falsification of the content or appearance of this document is unlawful and offenders may be prosecuted to the fullest extent of the law.

*All View of EUT-1*



*All View of EUT-2*



Unless otherwise stated the results shown in this test report refer only to the sample(s) tested and such sample(s) are retained for 90 days only.  
 除非另有說明，此報告結果僅對測試之樣品負責，同時此樣品僅保留90天。本報告未經本公司書面許可，不可部份複製。

This document is issued by the Company subject to its General Conditions of Service printed overleaf, available on request or accessible at [www.sgs.com/terms\\_and\\_conditions.htm](http://www.sgs.com/terms_and_conditions.htm) and, for electronic format documents, subject to Terms and Conditions for Electronic Documents at [www.sgs.com/terms\\_e-document.htm](http://www.sgs.com/terms_e-document.htm). Attention is drawn to the limitation of liability, indemnification and jurisdiction issues defined therein. Any holder of this document is advised that information contained hereon reflects the Company's findings at the time of its intervention only and within the limits of Client's instructions, if any. The Company's sole responsibility is to its Client and this document does not exonerate parties to a transaction from exercising all their rights and obligations under the transaction documents. This document cannot be reproduced except in full, without prior written approval of the Company. Any unauthorized alteration, forgery or falsification of the content or appearance of this document is unlawful and offenders may be prosecuted to the fullest extent of the law.



*Front View of EUT*



*Back View of EUT*



Unless otherwise stated the results shown in this test report refer only to the sample(s) tested and such sample(s) are retained for 90 days only.  
 除非另有說明，此報告結果僅對測試之樣品負責，同時此樣品僅保留90天。本報告未經本公司書面許可，不可部份複製。

This document is issued by the Company subject to its General Conditions of Service printed overleaf, available on request or accessible at [www.sgs.com/terms\\_and\\_conditions.htm](http://www.sgs.com/terms_and_conditions.htm) and, for electronic format documents, subject to Terms and Conditions for Electronic Documents at [www.sgs.com/terms\\_e-document.htm](http://www.sgs.com/terms_e-document.htm). Attention is drawn to the limitation of liability, indemnification and jurisdiction issues defined therein. Any holder of this document is advised that information contained hereon reflects the Company's findings at the time of its intervention only and within the limits of Client's instructions, if any. The Company's sole responsibility is to its Client and this document does not exonerate parties to a transaction from exercising all their rights and obligations under the transaction documents. This document cannot be reproduced except in full, without prior written approval of the Company. Any unauthorized alteration, forgery or falsification of the content or appearance of this document is unlawful and offenders may be prosecuted to the fullest extent of the law.



*Side View of EUT – 1*



*Side View of EUT – 2*



Unless otherwise stated the results shown in this test report refer only to the sample(s) tested and such sample(s) are retained for 90 days only.

除非另有說明，此報告結果僅對測試之樣品負責，同時此樣品僅保留90天。本報告未經本公司書面許可，不可部份複製。

This document is issued by the Company subject to its General Conditions of Service printed overleaf, available on request or accessible at [www.sgs.com/terms\\_and\\_conditions.htm](http://www.sgs.com/terms_and_conditions.htm) and, for electronic format documents, subject to Terms and Conditions for Electronic Documents at [www.sgs.com/terms\\_e-document.htm](http://www.sgs.com/terms_e-document.htm). Attention is drawn to the limitation of liability, indemnification and jurisdiction issues defined therein. Any holder of this document is advised that information contained hereon reflects the Company's findings at the time of its intervention only and within the limits of Client's instructions, if any. The Company's sole responsibility is to its Client and this document does not exonerate parties to a transaction from exercising all their rights and obligations under the transaction documents. This document cannot be reproduced except in full, without prior written approval of the Company. Any unauthorized alteration, forgery or falsification of the content or appearance of this document is unlawful and offenders may be prosecuted to the fullest extent of the law.

*Side View of EUT – 3*



*Side View of EUT – 4*



Unless otherwise stated the results shown in this test report refer only to the sample(s) tested and such sample(s) are retained for 90 days only.

除非另有說明，此報告結果僅對測試之樣品負責，同時此樣品僅保留90天。本報告未經本公司書面許可，不可部份複製。

This document is issued by the Company subject to its General Conditions of Service printed overleaf, available on request or accessible at [www.sgs.com/terms\\_and\\_conditions.htm](http://www.sgs.com/terms_and_conditions.htm) and, for electronic format documents, subject to Terms and Conditions for Electronic Documents at [www.sgs.com/terms\\_e-document.htm](http://www.sgs.com/terms_e-document.htm). Attention is drawn to the limitation of liability, indemnification and jurisdiction issues defined therein. Any holder of this document is advised that information contained hereon reflects the Company's findings at the time of its intervention only and within the limits of Client's instructions, if any. The Company's sole responsibility is to its Client and this document does not exonerate parties to a transaction from exercising all their rights and obligations under the transaction documents. This document cannot be reproduced except in full, without prior written approval of the Company. Any unauthorized alteration, forgery or falsification of the content or appearance of this document is unlawful and offenders may be prosecuted to the fullest extent of the law.

## USB Dock



## Car Charger



Unless otherwise stated the results shown in this test report refer only to the sample(s) tested and such sample(s) are retained for 90 days only.  
 除非另有說明，此報告結果僅對測試之樣品負責，同時此樣品僅保留90天。本報告未經本公司書面許可，不可部份複製。

This document is issued by the Company subject to its General Conditions of Service printed overleaf, available on request or accessible at [www.sgs.com/terms\\_and\\_conditions.htm](http://www.sgs.com/terms_and_conditions.htm) and, for electronic format documents, subject to Terms and Conditions for Electronic Documents at [www.sgs.com/terms\\_e-document.htm](http://www.sgs.com/terms_e-document.htm). Attention is drawn to the limitation of liability, indemnification and jurisdiction issues defined therein. Any holder of this document is advised that information contained hereon reflects the Company's findings at the time of its intervention only and within the limits of Client's instructions, if any. The Company's sole responsibility is to its Client and this document does not exonerate parties to a transaction from exercising all their rights and obligations under the transaction documents. This document cannot be reproduced except in full, without prior written approval of the Company. Any unauthorized alteration, forgery or falsification of the content or appearance of this document is unlawful and offenders may be prosecuted to the fullest extent of the law.

*Front View of Battery*

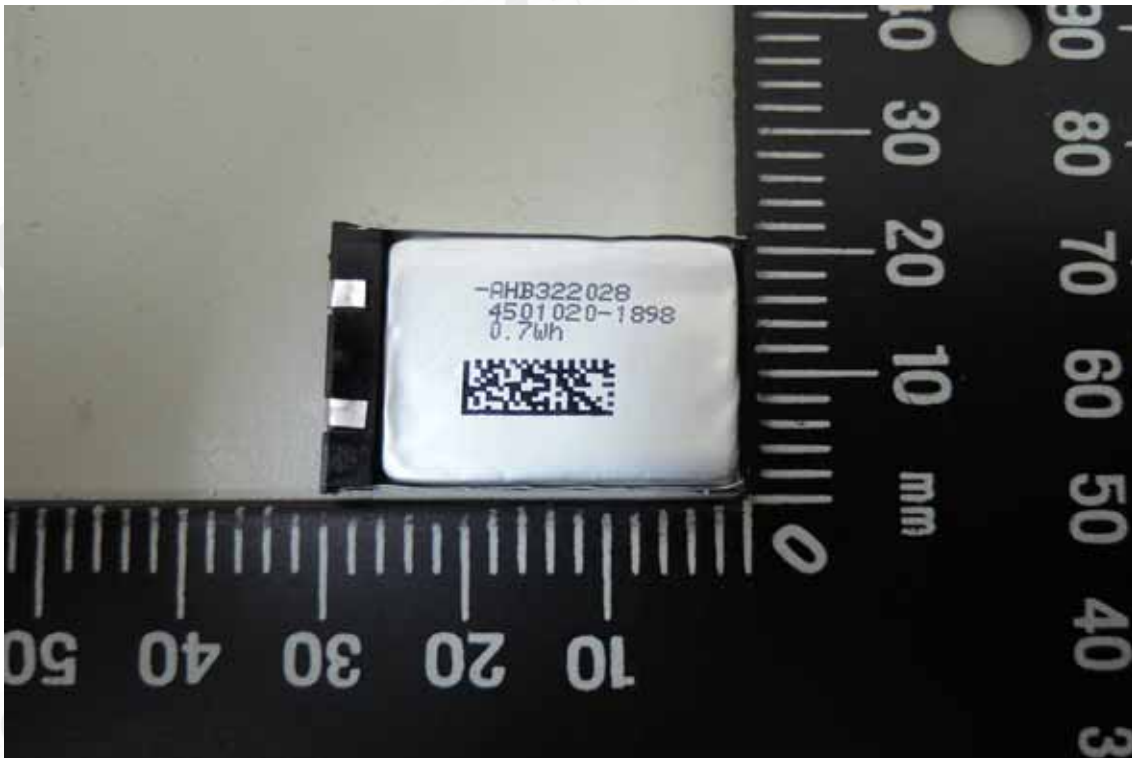

*Back View of Battery*



Unless otherwise stated the results shown in this test report refer only to the sample(s) tested and such sample(s) are retained for 90 days only.  
 除非另有說明，此報告結果僅對測試之樣品負責，同時此樣品僅保留90天。本報告未經本公司書面許可，不可部份複製。

This document is issued by the Company subject to its General Conditions of Service printed overleaf, available on request or accessible at [www.sgs.com/terms\\_and\\_conditions.htm](http://www.sgs.com/terms_and_conditions.htm) and, for electronic format documents, subject to Terms and Conditions for Electronic Documents at [www.sgs.com/terms\\_e-document.htm](http://www.sgs.com/terms_e-document.htm). Attention is drawn to the limitation of liability, indemnification and jurisdiction issues defined therein. Any holder of this document is advised that information contained herein reflects the Company's findings at the time of its intervention only and within the limits of Client's instructions, if any. The Company's sole responsibility is to its Client and this document does not exonerate parties to a transaction from exercising all their rights and obligations under the transaction documents. This document cannot be reproduced except in full, without prior written approval of the Company. Any unauthorized alteration, forgery or falsification of the content or appearance of this document is unlawful and offenders may be prosecuted to the fullest extent of the law.



*Open View of EUT-1*



*Open View of EUT-2*



Unless otherwise stated the results shown in this test report refer only to the sample(s) tested and such sample(s) are retained for 90 days only.  
 除非另有說明，此報告結果僅對測試之樣品負責，同時此樣品僅保留90天。本報告未經本公司書面許可，不可部份複製。

This document is issued by the Company subject to its General Conditions of Service printed overleaf, available on request or accessible at [www.sgs.com/terms\\_and\\_conditions.htm](http://www.sgs.com/terms_and_conditions.htm) and, for electronic format documents, subject to Terms and Conditions for Electronic Documents at [www.sgs.com/terms\\_e-document.htm](http://www.sgs.com/terms_e-document.htm). Attention is drawn to the limitation of liability, indemnification and jurisdiction issues defined therein. Any holder of this document is advised that information contained herein reflects the Company's findings at the time of its intervention only and within the limits of Client's instructions, if any. The Company's sole responsibility is to its Client and this document does not exonerate parties to a transaction from exercising all their rights and obligations under the transaction documents. This document cannot be reproduced except in full, without prior written approval of the Company. Any unauthorized alteration, forgery or falsification of the content or appearance of this document is unlawful and offenders may be prosecuted to the fullest extent of the law.

*Open View of EUT-3*



*Open View of EUT-4*



Unless otherwise stated the results shown in this test report refer only to the sample(s) tested and such sample(s) are retained for 90 days only.  
 除非另有說明，此報告結果僅對測試之樣品負責，同時此樣品僅保留90天。本報告未經本公司書面許可，不可部份複製。

This document is issued by the Company subject to its General Conditions of Service printed overleaf, available on request or accessible at [www.sgs.com/terms\\_and\\_conditions.htm](http://www.sgs.com/terms_and_conditions.htm) and, for electronic format documents, subject to Terms and Conditions for Electronic Documents at [www.sgs.com/terms\\_e-document.htm](http://www.sgs.com/terms_e-document.htm). Attention is drawn to the limitation of liability, indemnification and jurisdiction issues defined therein. Any holder of this document is advised that information contained herein reflects the Company's findings at the time of its intervention only and within the limits of Client's instructions, if any. The Company's sole responsibility is to its Client and this document does not exonerate parties to a transaction from exercising all their rights and obligations under the transaction documents. This document cannot be reproduced except in full, without prior written approval of the Company. Any unauthorized alteration, forgery or falsification of the content or appearance of this document is unlawful and offenders may be prosecuted to the fullest extent of the law.



*Open View of EUT-5*



*Open View of EUT-6*

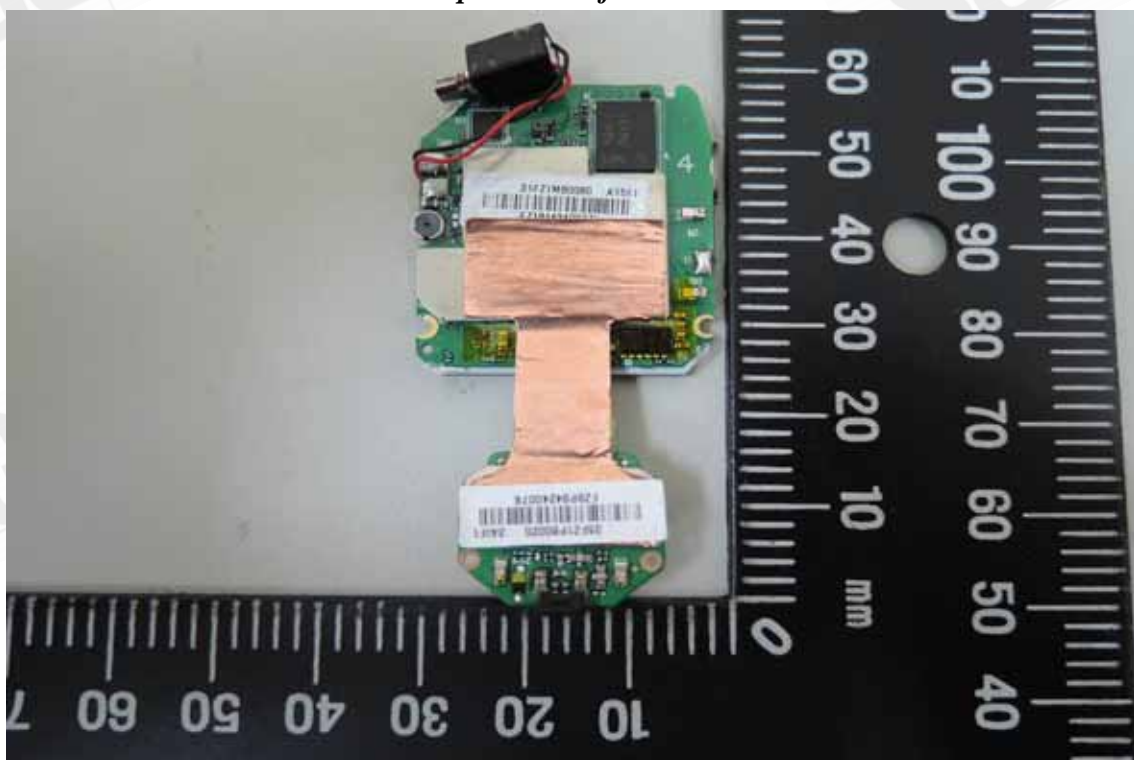

Unless otherwise stated the results shown in this test report refer only to the sample(s) tested and such sample(s) are retained for 90 days only.  
 除非另有說明，此報告結果僅對測試之樣品負責，同時此樣品僅保留90天。本報告未經本公司書面許可，不可部份複製。

This document is issued by the Company subject to its General Conditions of Service printed overleaf, available on request or accessible at [www.sgs.com/terms\\_and\\_conditions.htm](http://www.sgs.com/terms_and_conditions.htm) and, for electronic format documents, subject to Terms and Conditions for Electronic Documents at [www.sgs.com/terms\\_e-document.htm](http://www.sgs.com/terms_e-document.htm). Attention is drawn to the limitation of liability, indemnification and jurisdiction issues defined therein. Any holder of this document is advised that information contained hereon reflects the Company's findings at the time of its intervention only and within the limits of Client's instructions, if any. The Company's sole responsibility is to its Client and this document does not exonerate parties to a transaction from exercising all their rights and obligations under the transaction documents. This document cannot be reproduced except in full, without prior written approval of the Company. Any unauthorized alteration, forgery or falsification of the content or appearance of this document is unlawful and offenders may be prosecuted to the fullest extent of the law.

*Internal View of EUT-1*

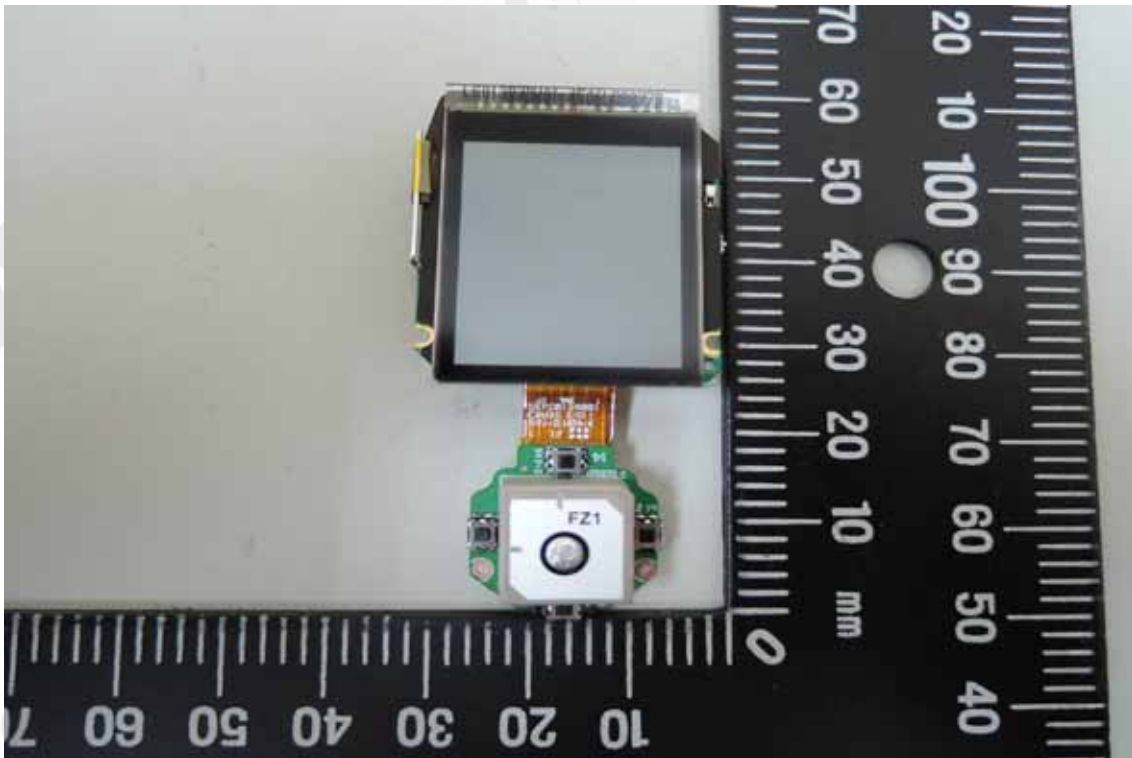

*Internal View of EUT-2*

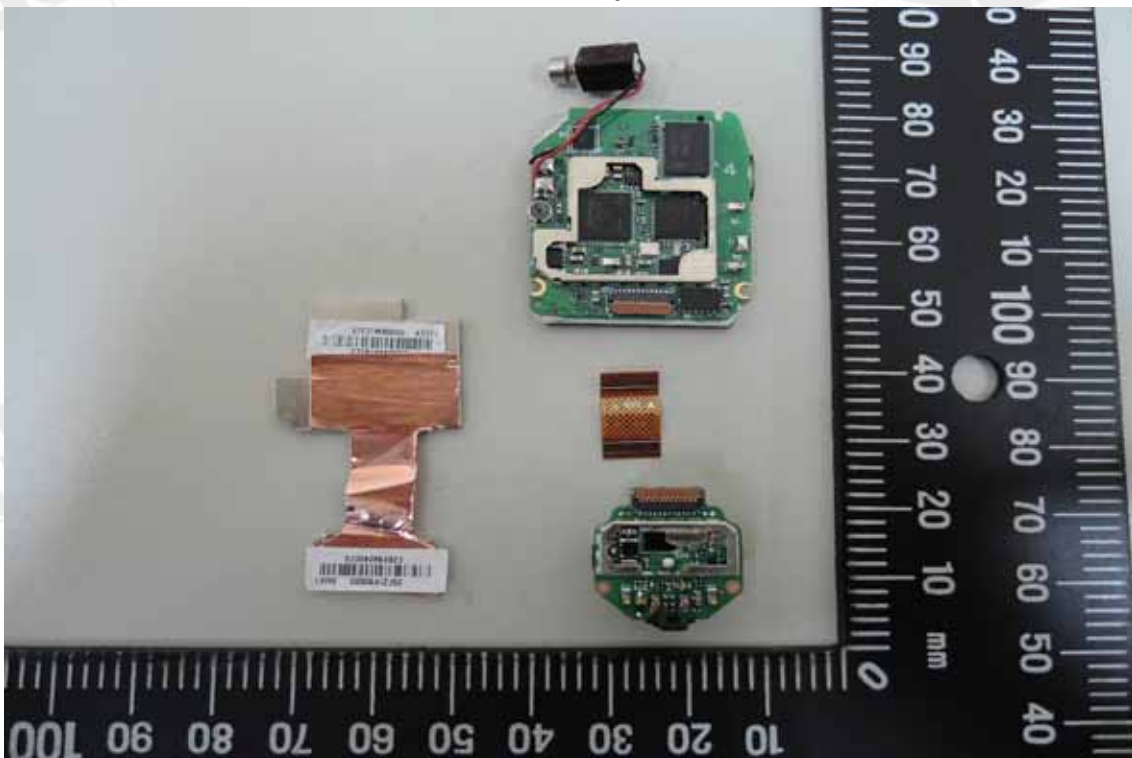

Unless otherwise stated the results shown in this test report refer only to the sample(s) tested and such sample(s) are retained for 90 days only.  
 除非另有說明，此報告結果僅對測試之樣品負責，同時此樣品僅保留90天。本報告未經本公司書面許可，不可部份複製。

This document is issued by the Company subject to its General Conditions of Service printed overleaf, available on request or accessible at [www.sgs.com/terms\\_and\\_conditions.htm](http://www.sgs.com/terms_and_conditions.htm) and, for electronic format documents, subject to Terms and Conditions for Electronic Documents at [www.sgs.com/terms\\_e-document.htm](http://www.sgs.com/terms_e-document.htm). Attention is drawn to the limitation of liability, indemnification and jurisdiction issues defined therein. Any holder of this document is advised that information contained hereon reflects the Company's findings at the time of its intervention only and within the limits of Client's instructions, if any. The Company's sole responsibility is to its Client and this document does not exonerate parties to a transaction from exercising all their rights and obligations under the transaction documents. This document cannot be reproduced except in full, without prior written approval of the Company. Any unauthorized alteration, forgery or falsification of the content or appearance of this document is unlawful and offenders may be prosecuted to the fullest extent of the law.

*Internal View of EUT-3*

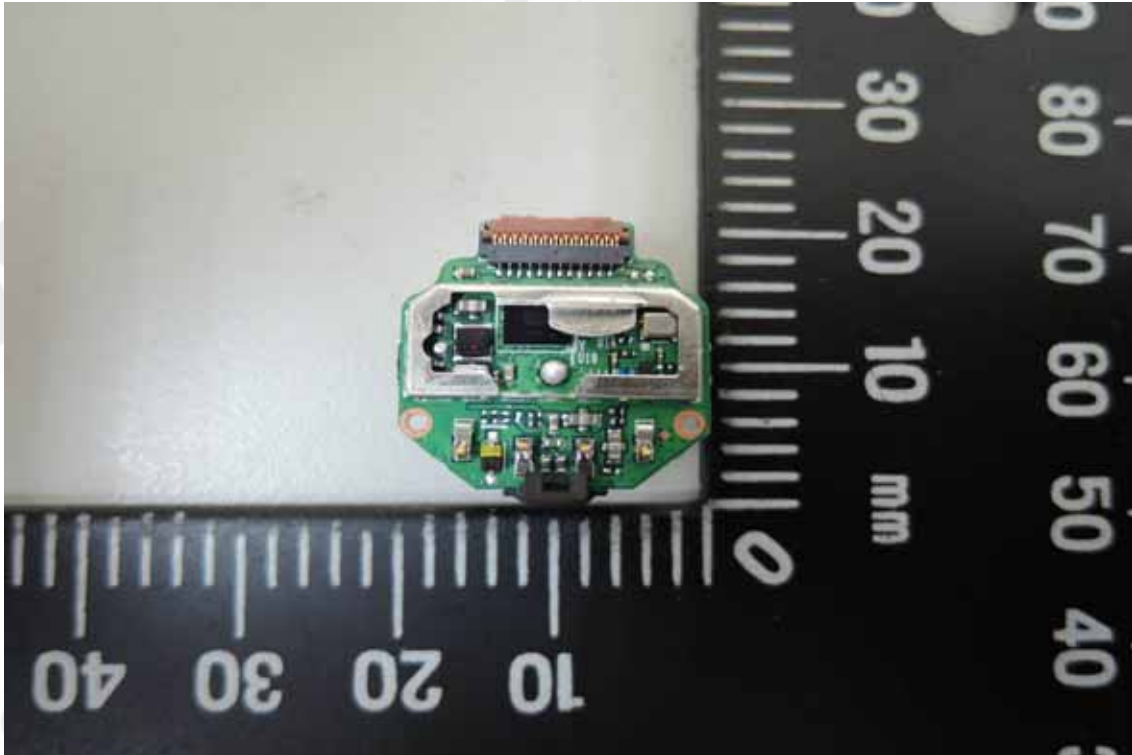

*Internal View of EUT-4*

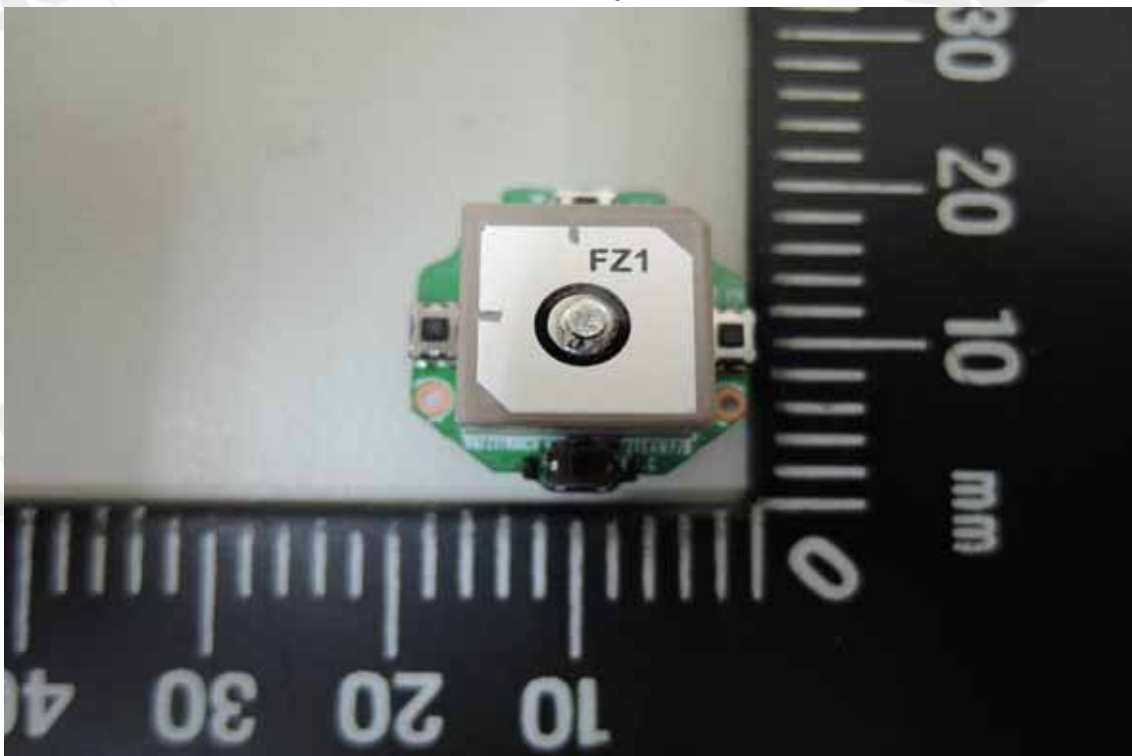

Unless otherwise stated the results shown in this test report refer only to the sample(s) tested and such sample(s) are retained for 90 days only.  
 除非另有說明，此報告結果僅對測試之樣品負責，同時此樣品僅保留90天。本報告未經本公司書面許可，不可部份複製。

This document is issued by the Company subject to its General Conditions of Service printed overleaf, available on request or accessible at [www.sgs.com/terms\\_and\\_conditions.htm](http://www.sgs.com/terms_and_conditions.htm) and, for electronic format documents, subject to Terms and Conditions for Electronic Documents at [www.sgs.com/terms\\_e-document.htm](http://www.sgs.com/terms_e-document.htm). Attention is drawn to the limitation of liability, indemnification and jurisdiction issues defined therein. Any holder of this document is advised that information contained herein reflects the Company's findings at the time of its intervention only and within the limits of Client's instructions, if any. The Company's sole responsibility is to its Client and this document does not exonerate parties to a transaction from exercising all their rights and obligations under the transaction documents. This document cannot be reproduced except in full, without prior written approval of the Company. Any unauthorized alteration, forgery or falsification of the content or appearance of this document is unlawful and offenders may be prosecuted to the fullest extent of the law.



*Internal View of EUT-5*

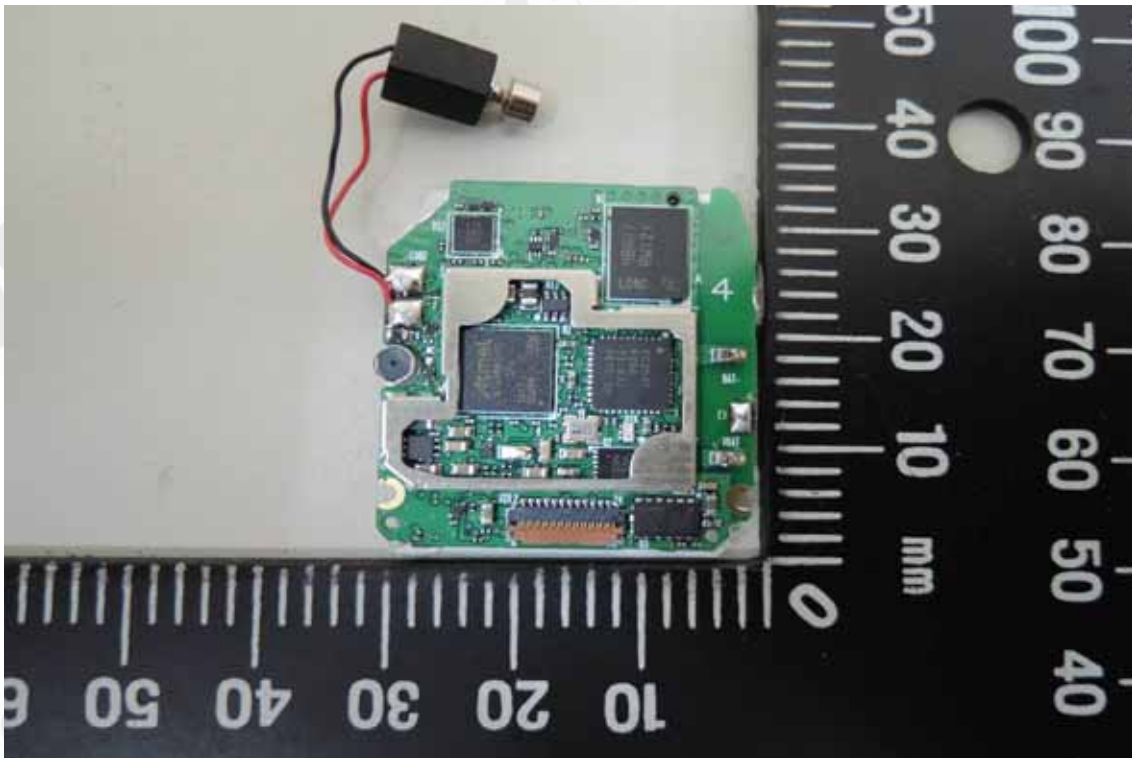

*Internal View of EUT-6*

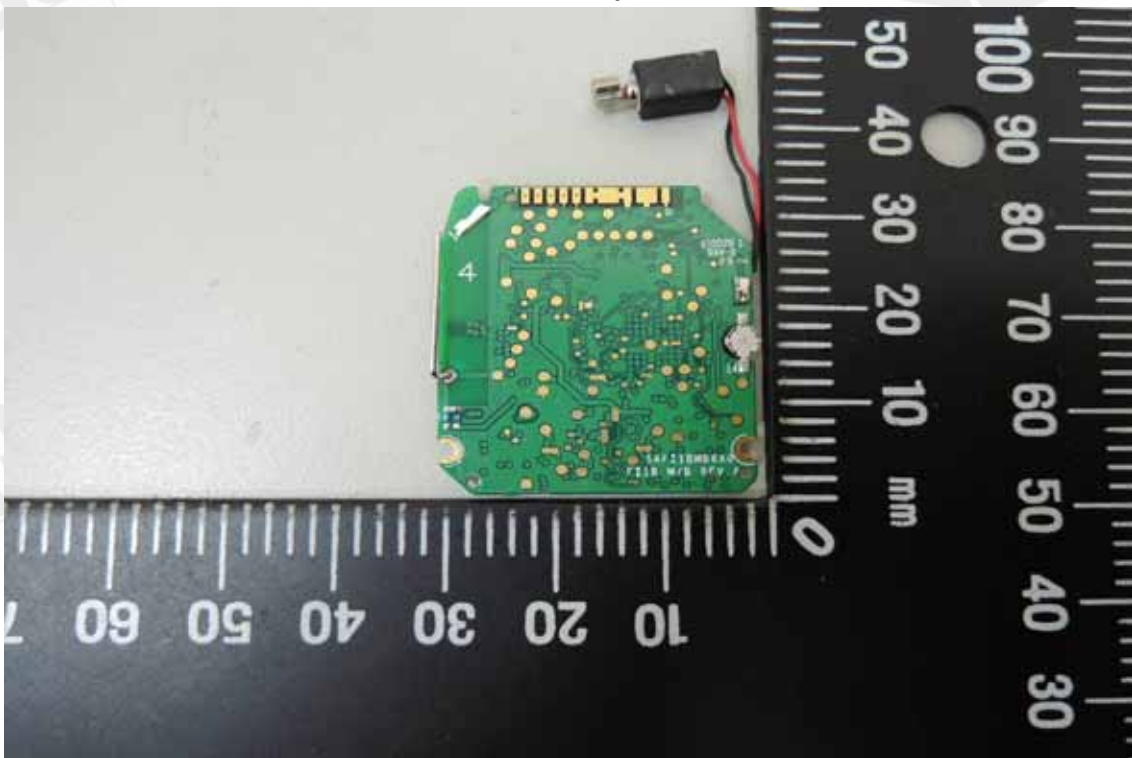

Unless otherwise stated the results shown in this test report refer only to the sample(s) tested and such sample(s) are retained for 90 days only.  
 除非另有說明，此報告結果僅對測試之樣品負責，同時此樣品僅保留90天。本報告未經本公司書面許可，不可部份複製。

This document is issued by the Company subject to its General Conditions of Service printed overleaf, available on request or accessible at [www.sgs.com/terms\\_and\\_conditions.htm](http://www.sgs.com/terms_and_conditions.htm) and, for electronic format documents, subject to Terms and Conditions for Electronic Documents at [www.sgs.com/terms\\_e-document.htm](http://www.sgs.com/terms_e-document.htm). Attention is drawn to the limitation of liability, indemnification and jurisdiction issues defined therein. Any holder of this document is advised that information contained herein reflects the Company's findings at the time of its intervention only and within the limits of Client's instructions, if any. The Company's sole responsibility is to its Client and this document does not exonerate parties to a transaction from exercising all their rights and obligations under the transaction documents. This document cannot be reproduced except in full, without prior written approval of the Company. Any unauthorized alteration, forgery or falsification of the content or appearance of this document is unlawful and offenders may be prosecuted to the fullest extent of the law.

*Internal View of EUT-7*



*Internal View of EUT-8*



Unless otherwise stated the results shown in this test report refer only to the sample(s) tested and such sample(s) are retained for 90 days only.  
 除非另有說明，此報告結果僅對測試之樣品負責，同時此樣品僅保留90天。本報告未經本公司書面許可，不可部份複製。

This document is issued by the Company subject to its General Conditions of Service printed overleaf, available on request or accessible at [www.sgs.com/terms\\_and\\_conditions.htm](http://www.sgs.com/terms_and_conditions.htm) and, for electronic format documents, subject to Terms and Conditions for Electronic Documents at [www.sgs.com/terms\\_e-document.htm](http://www.sgs.com/terms_e-document.htm). Attention is drawn to the limitation of liability, indemnification and jurisdiction issues defined therein. Any holder of this document is advised that information contained herein reflects the Company's findings at the time of its intervention only and within the limits of Client's instructions, if any. The Company's sole responsibility is to its Client and this document does not exonerate parties to a transaction from exercising all their rights and obligations under the transaction documents. This document cannot be reproduced except in full, without prior written approval of the Company. Any unauthorized alteration, forgery or falsification of the content or appearance of this document is unlawful and offenders may be prosecuted to the fullest extent of the law.



*BT Antenna*

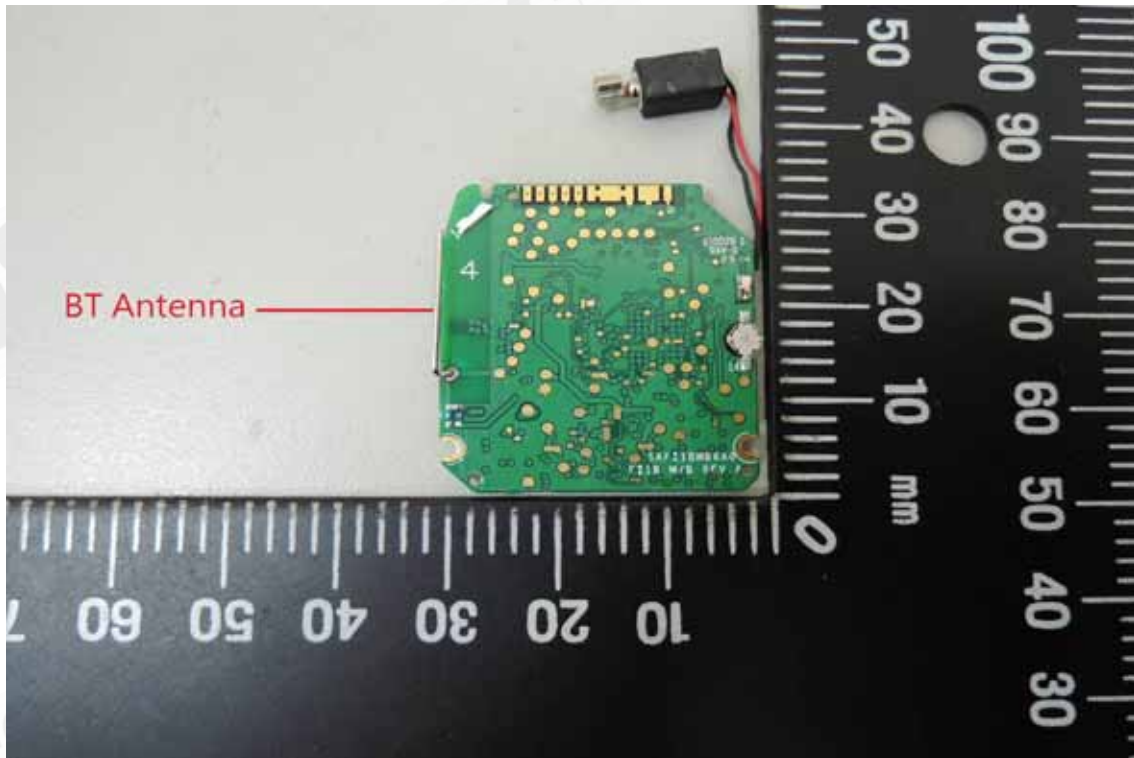

~ End of Report ~

Unless otherwise stated the results shown in this test report refer only to the sample(s) tested and such sample(s) are retained for 90 days only.  
 除非另有說明，此報告結果僅對測試之樣品負責，同時此樣品僅保留90天。本報告未經本公司書面許可，不可部份複製。

This document is issued by the Company subject to its General Conditions of Service printed overleaf, available on request or accessible at [www.sgs.com/terms\\_and\\_conditions.htm](http://www.sgs.com/terms_and_conditions.htm) and, for electronic format documents, subject to Terms and Conditions for Electronic Documents at [www.sgs.com/terms\\_e-document.htm](http://www.sgs.com/terms_e-document.htm). Attention is drawn to the limitation of liability, indemnification and jurisdiction issues defined therein. Any holder of this document is advised that information contained hereon reflects the Company's findings at the time of its intervention only and within the limits of Client's instructions, if any. The Company's sole responsibility is to its Client and this document does not exonerate parties to a transaction from exercising all their rights and obligations under the transaction documents. This document cannot be reproduced except in full, without prior written approval of the Company. Any unauthorized alteration, forgery or falsification of the content or appearance of this document is unlawful and offenders may be prosecuted to the fullest extent of the law.